

### 注意事項

- 燈具安裝請詳細閱讀以下重要事項:
1. 燈具安裝·維護前·必須切斷電源·以防觸電!
  2. 為確保安全·請委託有經驗的電氣專業人員負責安裝維修及保養燈具·
  3. 如燈具發生異常現象·請迅速切斷電源·並請專業人員進行處理·
  4. LED地埋燈·用於走廊·花園·公園的指示燈·在這些區域不能超過5MM·當安裝在無人行走的地方·如靠近牆體或者建築·這些區域不能超過25MM·

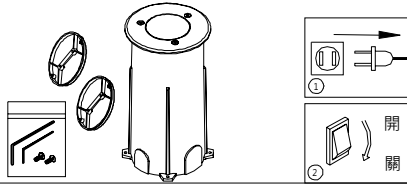

### 1. 正確安裝方式

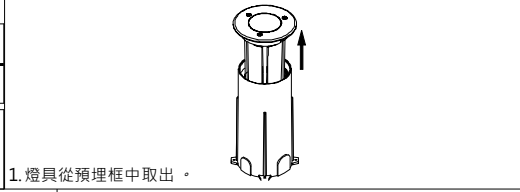
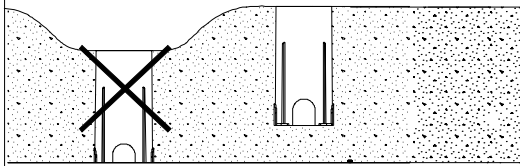

1. 燈具從預理框中取出。

### 2.

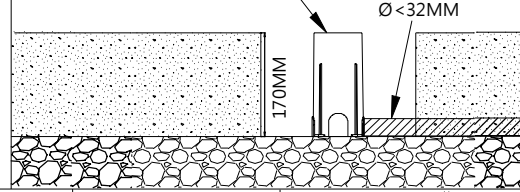
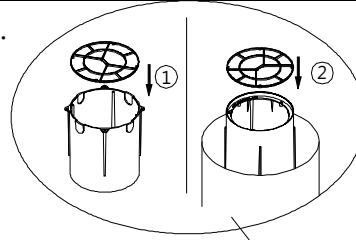

### 3.

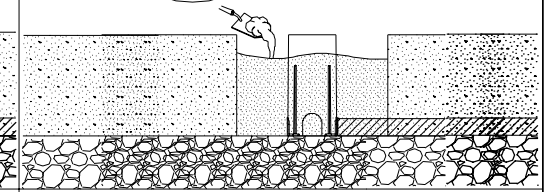
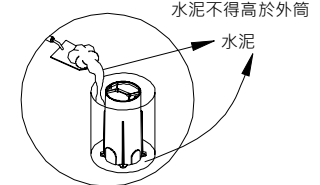

### 4.

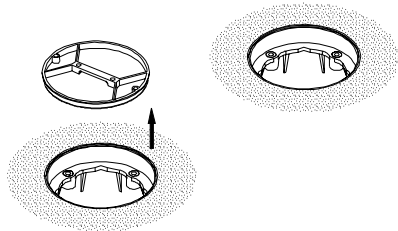

4. 取出安裝筒的蓋子。

### 5.

#### 1. 石材安裝方式

注意：依據現場石材厚度及覆蓋水泥厚度預留高度。

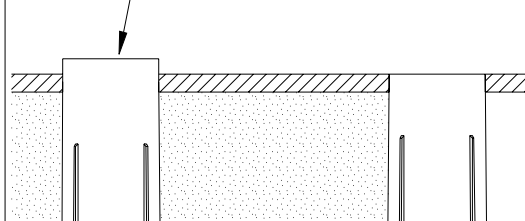

#### 2. 混凝土安裝方式

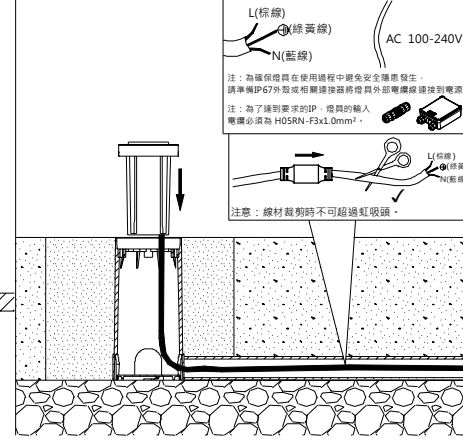

### 6.

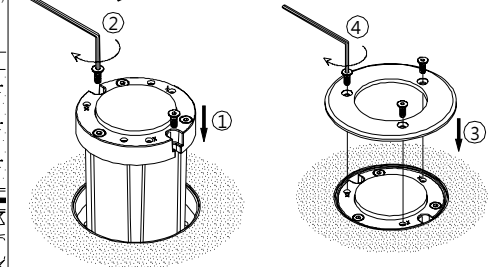
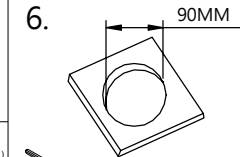

### 7. 使用附件配件內六角扳手·取出燈具固定面板。

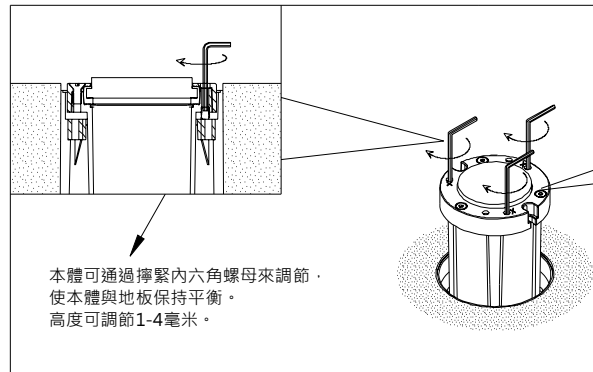
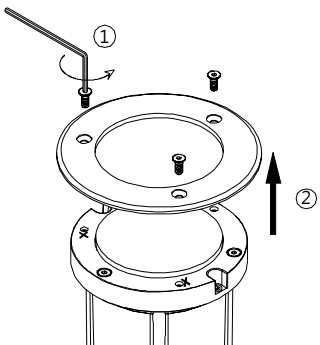

#### 燈具調節所需的出光角度步驟示意圖。

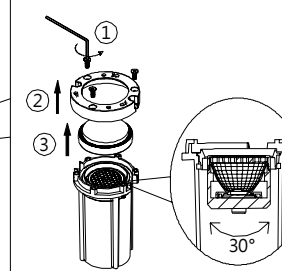

注意：如需調節燈具角度·在鎖定面板之前·請點亮燈具·讓空氣蒸發·然後再鎖緊燈具面板。

### 8.

